



LINN COUNTY PLANNING AND BUILDING DEPARTMENT

Steve Wills – Director
Rick Goff – Building Official

Room 114, Linn County Courthouse
PO Box 100, Albany, Oregon 97321
Phone 541-967-3816, Fax 541-926-2060

Required Inspections for Manufacture Home Placement

General Information

It is the responsibility of the permit holder to see that all inspections are made at the proper time and the address and lime green locator card are visible from the road. The yellow inspection card must be on the job site at all times. Inspections may be requested at any time by calling (541) 967-3816, option 1.

All inspections shall be made and approval given before the home is occupied.

When an inspector must enter an occupied building to make an inspection, the owner must accompany the inspector or an adult authorized by the owner. If the building is unoccupied and there are no personal items in the building, the inspector may go in to make the inspection. If there are any personal items in the building, the inspector will not enter the building.

Order of Inspections – Each item must be scheduled for inspection in sequence

- **Site Inspection** – Before doing any excavation or fill, a site inspection is required to determine stability of the soil. A separate grading or fill permit may be required per Linn County Fill and Ordinance *if* cut and fill exceeds 50 cubic yards or placed at a depth greater than 6-inches; this will require an Engineered Geology Report.
 - **Note:** Any fill greater than 6-inches in depth requires a compaction report.

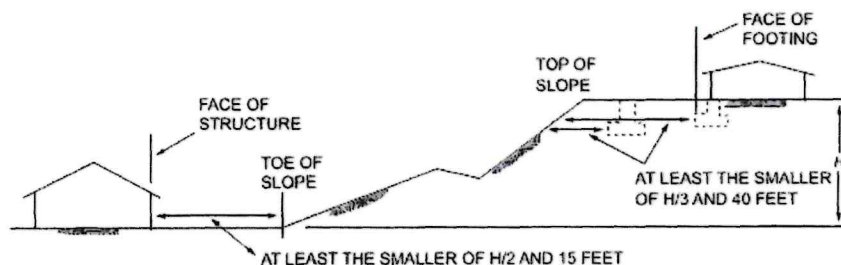

- **Concrete Footings (Stringers or Slab)** – To be made after forms are erected and all required reinforcement steel is in place, but prior to pouring any concrete. *All property lines must be identified.*
- **Service Pedestal – Electrical** – After service pedestal and meter base has been installed. If service is approved, the inspector will place a green tag and the power company can energize.
- **Blocking and Utilities** – After the home is blocked, cross-over connections, vapor barrier, bonding, feeder electrical line hooked up, all water and sewer connections are made (*prior to burial of all utility lines*). **Skirting shall not be installed until after the installation inspection has been approved.**
- **Final** – After the unit is skirted with the ventilation in place, decks, landings, stairs, hand and guardrails, and grading is completed. **If skirting is installed prior to the installation inspection, the permit applicant may be subject to a re-inspection fee of \$90.**



LINN COUNTY PLANNING AND BUILDING DEPARTMENT

Robert Wheeldon, Director

Room 114, Linn County Courthouse
PO Box 100, Albany, Oregon 97321
Phone 541-967-3816
Fax 541-926-2060 www.co.linn.or.us

ORS 446.245 Permitted Uses of Manufactured Dwellings

(3)(a) Manufactured dwellings may be used for purposes other than as a single-family dwelling when specifically approved for a change in occupancy in accordance with the provisions of the Oregon specialty codes by the authority having jurisdiction. When a manufactured dwelling change in occupancy it shall lose its identity as a manufactured dwelling and have the insignia removed and returned to the Department of Consumer and Business Services.

Linn County Code allows for manufactured dwellings to be used for purposes other than residential uses in resource zones (FCM, F/F, and EFU) and certain commercial and industrial zones (AB, FIC, HI, LI, RCM, UD-I, and UD-II).

Linn County Policy:

1. A placement permit shall be obtained from the Linn County Planning and Building Department for manufactured dwelling units being located and/or relocated on a property. All manufactured dwelling units shall be installed to Linn County Code for:
 - a. Foundation systems
 - b. Structural connections
 - c. Anchoring systems
 - d. Skirting
 - e. Ventilation
 - f. Electrical connections
 - g. Plumbing connections
 - h. Mechanical
 - i. Access
2. For existing manufactured dwelling units to be used for purposes other than a dwelling, a permit shall be obtained from the Linn County Planning and Building Department for a change of use. The special inspection permit fee is \$65.00 per hour, with a two-hour minimum.
3. For new or existing manufactured dwelling units, the dwelling unit shall be altered by removal of all the plumbing and electrical systems serving either the:
 - a. Kitchen, or
 - b. Bathrooms

NOTE: Removal of all the plumbing means all drain, waste, and vent pipes, all water distribution piping that served the fixtures, and all fixtures. In the case of a kitchen, fixtures mean the sink, dishwasher, and any refrigerator that provides water. In the case of a bathroom, fixtures mean all toilets, all lavatories, and all showers and/or bathtubs.

Removal of all the electrical systems means all 240 volt outlets and conductors from the breaker serving that branch circuit (kitchen range).

All kitchen appliances must be removed from the manufactured dwelling unit.



LINN COUNTY PLANNING AND BUILDING DEPARTMENT

Steve Wills - Director
Rick Goff - Building Official

Room 114, Linn County Courthouse PO
Box 100, Albany, Oregon 97321 Phone
541-967-3816, Fax 541-926-2060

Manufactured Dwelling Application

Linn County approvals must be obtained before a building permit can be issued.

1. LAND USE APPROVAL:

- a) If your building project is within a city, you must obtain land use approval from the city.
- b) If your building project is within Linn County and not within the city limits, land use approval must be obtained from the Linn County Planning and Building Department.

Note: Some planning reviews or hearings may delay your project. You should begin this process well before you wish to start building. Talk to the city or county planner about your project for specific requirements.

2. SANITATION:

- a) If your property is served by a municipal sewer system, approval must be obtained from the municipality.
- b) If a public system is not available, an on-site sewage disposal system may be used. For information regarding an existing or new disposal system, contact Environmental Health at (541) 967-3821.
Please contact this department regardless of the type of proposed structure.

Note: Some delay may be experienced in obtaining sanitation approval. You should begin this process well before you wish to start building. Talk to a sanitarian about your project for specific requirements.

3. ROADS AUTHORITY:

- a) Prior to submitting for a permit, obtain approval from one of the following: Linn County Road Department at (541) 967-3919, Oregon Department of Transportation at (503) 986-3435, or your local municipality.

4. FIRE AUTHORITY:

- a) Prior to submitting for a permit, obtain comments from the local fire authority.

5. BUILDING PLAN REVIEW:

- a) *Residential:* See Requirements and Submittals Checklist.
- b) *Commercial:* See Requirements and Submittals Checklist. A pre-application meeting may be required for commercial or industrial building projects. Contact the Linn County Building Official for this determination.



LINN COUNTY PLANNING AND BUILDING DEPARTMENT

Steve Wills – Director
Rick Goff – Building Official

Room 114, Linn County Courthouse
PO Box 100, Albany, Oregon 97321
Phone 541-967-3816, Fax 541-926-2060

Manufactured Dwelling Plot Plan Permit Application Checklist

Permit number _____
Map number _____

The following items are required for plan review and shall be used by Linn County to determine a complete plot plan and compliance with OAR 918-500-0060.

- 1. Site/Plot plan drawn to scale. Yes N/A
2. Approximate elevations at each corner of the lot. Yes N/A
3. Location of all cuts and fills on lot. Yes N/A
4. Location of the manufactured dwelling and all accessory buildings and structures including walls. Yes N/A
5. Setbacks from property lines, lot lines, streets, public sidewalks, easements of record and other structures on the same or adjacent lots. Yes N/A
6. Intended finished grade. Yes N/A
7. Location and type of all site drainage including rain drains. Yes N/A
8. Where there is more than 12-inch difference in elevation between two adjacent corners of a site, the plot plan shall include contour lines or shall be submitted with a cross-sectional drawing of the lot showing the approximate elevations of the lot. Yes N/A
9. When installed outside a manufactured dwelling park, other information such as location of wells, septic tanks, leach lines, petroleum tanks, natural waterways, easements of record and other information necessary to assure health and safety may be required by Linn County. Yes N/A

Linn County Specific Requirements

- 1. Floodplain Elevation Certificate (Pre and Post Construction) Yes N/A
2. Geotechnical Report for Geohazard Areas Yes N/A

Checklist must be completed before plan review start date. Minor changes or notes on submitted plans may be in blue or black ink. Red ink is reserved for department use only.



LINN COUNTY PLANNING AND BUILDING DEPARTMENT

Steve Wills – Director
Rick Goff – Building Official

Room 114, Linn County Courthouse
PO Box 100, Albany, Oregon 97321
Phone 541-967-3816, Fax 541-926-2060

Linn County Manufactured Home Placement Permit Process

The first step in the process of placing a manufactured home on your property in Linn County is to obtain **Land Use Approval** from the Planning and Building Department.

After obtaining land use approval, the next step is to contact the Linn County **Environmental Health Department**. Disconnecting and reconnecting to a septic system requires a review.

Once you have been issued your septic permit, you may submit your **Placement Permit Application** to the city or county where the property is located. For properties located outside the city limits of Albany, Brownsville, Halsey, Harrisburg, Lebanon, Lyons, Mill City, Scio, Sweet Home, and Tangent, you will submit your placement permit to Linn County Planning and Building Department. The permit fees for this permit vary and are based on the size of the manufactured home (single, double, or triple) and any additional items such as a new electrical service, heat pump or air handler, wood burning, pellet stove or natural gas heater, or a well or septic pump.

After being issued your placement permit, you must contact the Tax Assessment office at the county that the manufactured home is presently located in to obtain your **Transportation Permit**. To obtain



this permit, you must have information on your manufactured home and the name of the transportation company.

You may also be required to file papers with the Tax Assessor's Office in regards to ownership of the manufactured home.

The following contact information is provided for any of the departments involved in this process:

Linn County Environmental Health
315 SW 4th Ave, 2nd floor
Albany, OR 97321
Phone (541) 967-3821
Fax (541) 924-6904

Linn County Planning and Building
300 SW 4th Ave, room 114
Albany, OR 97321
Phone (541) 967-3816
Fax (541) 926-2060

Linn County Assessment & Taxation
300 SW 4th Ave, room 214
Albany, OR 97321
Phone (541)967-3808
Fax (541) 917-7448



LINN COUNTY PLANNING AND BUILDING DEPARTMENT

Steve Wills – Director
Rick Goff – Building Official

Room 114, Linn County Courthouse
PO Box 100, Albany, Oregon 97321
Phone 541-967-3816, Fax 541-926-2060

Linn County Planning and Building Department Checklist for Manufactured Homes

Year Made _____ Make _____

Size _____ Serial or X Number _____

In an effort to have all the permits issued in one visit, please answer the following:

_____ Will the manufactured home be placed on concrete footings (runners) or a slab?
If yes, who will be doing the work? _____

Check one of the following:

Single Wide

Double Wide

Triple Wide

_____ Will you be installing a new electrical service?
If yes, who will be doing the installation? _____

_____ Is your manufactured home equipped with gas appliances?
If yes, who will be installing the gas line? _____

_____ Will you be installing a wood burning, pellet stove, or gas room heater?
If yes, who will be doing the work? _____

_____ Will your manufactured home be equipped with a heat pump or air conditioner?
If yes, who will be installing the electrical circuit(s)? _____

_____ Will you or an electrical contractor be installing either a septic or well pump?
If yes, who will be installing the electrical circuit(s)? _____

Owner/Contractor Signature

Date



Linn County
 PO Box 100 Rm 114
 300 SW 4th ST Rm 114
 Albany, OR 97321
 Phone: 541-967-3816
 Web: co.linn.or.us
 Email: planoffice@co.linn.or.us

MANUFACTURED DWELLING PLACEMENT PERMIT APPLICATION	DEPARTMENT USE ONLY
	Permit #:
	By: Date:

This permit is issued under OAR 918-440-0050. Permits expire if work is not started within 180 days of issuance or if work is suspended for 180 days.

CONSTRUCTION CATEGORY
<input type="checkbox"/> Manufactured Dwelling <i>For Mfd/RV Park, pull Area Development Permit separately – for Non-Dwelling Modular Placement Permit (ie. modular classroom, job trailer, etc), pull Structural Permit</i>
TYPE OF WORK
<input type="checkbox"/> New <input type="checkbox"/> Replacement <input type="checkbox"/> Other <i>For work defined as addition, alteration, or repair – a Residential Structural Application would be required.</i>
JOB SITE INFORMATION & LOCATION
Job site address:
City/State/ZIP:
Project Name:
Parcel #:
Directions to job site:
DESCRIPTION OF WORK
Job # (optional):
PROPERTY OWNER INSTALLATION
Name:
Address:
City/State/ZIP:
Phone:
Email:
<input type="checkbox"/> Owner acknowledges installation is being made on residential or farm property owned by me or a member of my immediate family. This property is not intended for sale, exchange, lease, or rent. ORS 479-540(1) and 479.560(1).
Signature:
CONTRACTOR INSTALLATION
Business name:
Address:
City/State/ZIP:
Phone:
Email:
Contractor CCB license #:
BCD license #:
MDI license #:

I hereby certify I have read and examined this application and know the same to be true and correct. All provisions of laws and ordinances governing this type of work will be complied with whether specified herein or not.	
Applicant Signature:	
REQUIRED INFORMATION	
Manufactured Home Siting Permit: One single permit is assessed to cover the installation and setup to include the concrete slab, runners or foundations when prescriptive, electrical feeder and plumbing connections (up to 30 lineal feet each – water, sewer, storm) and all cross-over connections.	
Associated Permits: The manufactured dwelling permit does not include utility connections beyond 30 lineal feet, new electrical services or additional branch circuits, new plumbing, and other such items that fall under the building code and may require separate permits up to and including decks, other accessory structures, and non-prescriptive foundations.	
Placement is: <input type="checkbox"/> Inside Park <input type="checkbox"/> Outside Park/Private Lot	
Number of Awnings:	
Serial Number:	
Length:	Width:
Height (original grade to highest roof point):	
Year:	Model:
Work being performed in Floodplain: <input type="checkbox"/> Yes <input type="checkbox"/> No	
MANUFACTURED DWELLING FEE SCHEDULE	
Mfd Dwelling Placement fee	\$
Earthquake-resistant bracing system install (if applicable)	\$
Subtotal: (add up ALL fees)	
12% surcharge (.12 x subtotal)	
State Manufactured Dwelling Fee	\$30.00
GRAND TOTAL (fees + surcharges)	

Planning Conditions	

Fire Department Conditions	

EH Conditions	

Roads Department Conditions	



Manufactured Home Placement Fees

Single Wide manufactured home Placement fee

1. Mobile or manufactured home installation
 - A. Single wide (base fee)\$506.85
 - B. Each additional section.....\$29.55
 - C. State Cabana Fee.....\$30.00
 - D. Linn County Planning fee.....\$150.00

Note: Manufactured home installation permits includes the concrete slab, runners of foundation that are prescriptive, electrical feeder and plumbing connections and all cross-over connections up to 30 lineal feet of site utilities. Decks, other accessory structures and foundations that are not prescriptive, utility connections beyond 30 lineal feet, new electrical services or additional branch circuits and new plumbing- may require separate permits. All decks 30" above ground, carports, garages, porches and patios are based on valuation and will require separate permits per OAR 918-050-0130

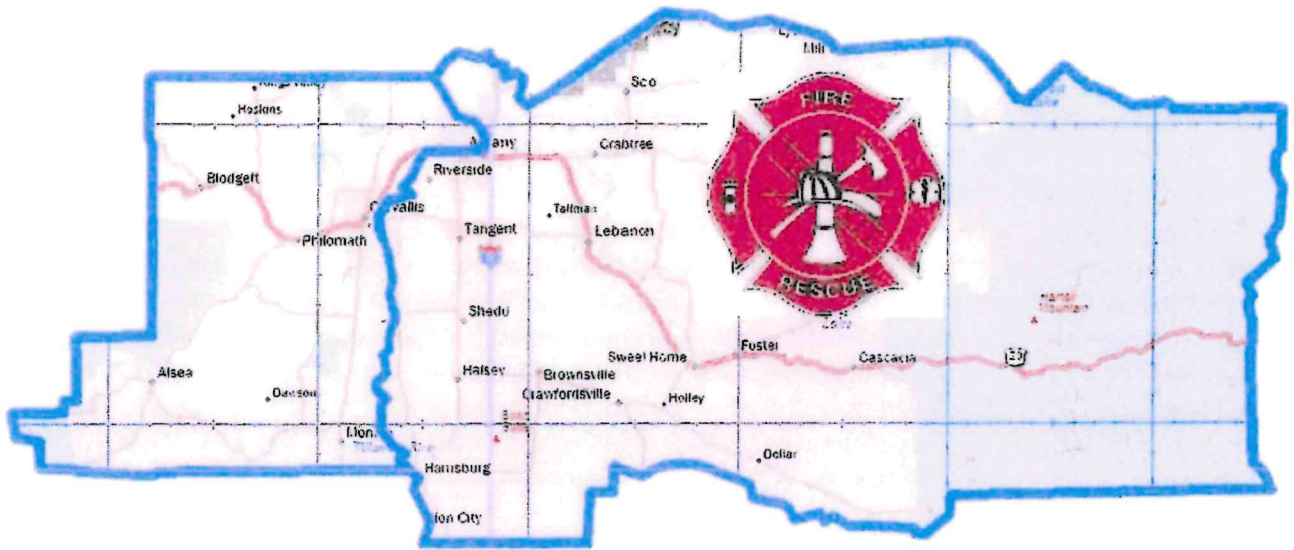

Linn and Benton County Fire Departments Access and Water Supply Application Guide

March 2023

**Based on 2022 Oregon Fire Code
Approved by the Linn and Benton County Fire Defense Boards**

PREAMBLE AND SCOPE OF AUTHORITY

The jurisdictions identified in Appendix A.1 of this document have elected to administer and enforce the Oregon Fire Code under the authority granted to them by ORS 476.030 and ORS 476.060.

In order to further the Oregon State Fire Marshal's goal of promoting fire code consistency throughout the state, the jurisdictions listed herein have agreed to apply these regulations uniformly throughout both Linn and Benton Counties.

The listed jurisdictions have prepared this document to provide good faith guidance to building officials, contractors, business owners, the public, and fire marshals on local interpretations and practices that are considered to be in compliance with the Oregon Fire Code. The intent is to clarify aspects of the code that are vague or non-specific by addressing selected issues under normal conditions. This document does not create or replace code provisions and is not an adopted policy of the above jurisdictions. The reader is cautioned that the guidance detailed in this document may or may not apply to their specific situation, and that the designated authority for each jurisdiction (AHJ) retains final authority to determine compliance.

THESE GUIDELINES DO NOT CREATE NOR REPLACE PROVISIONS OF THE OREGON FIRE CODE

Copies of the Oregon Fire Code may be obtained through the Oregon State Fire Marshal's website: https://www.oregon.gov/ospf/programs/sfmr/Pages/Fire_Codes.aspx.

APPLICATION

Application of the regulations contained herein, are based upon the following facts:

- Water supplies for fire protection of public buildings as specified in ORS 479.200, has been a requirement throughout the State of Oregon since July 1, 1967.
- Regulations for fire department access and fire protection water supplies for all buildings and facilities throughout the State of Oregon, has been a requirement of the Oregon Fire Code since July 15, 1992.

As such, these regulations shall apply to all structures, facilities, and conditions arising on or after October 1, 2022, and to all existing structures, facilities, and conditions; under any of the following situations (**Oregon Fire Code Chapter 1**):

- 1) Conditions not legally in existence as of October 1, 2022, or
- 2) Conditions when identified by specific sections of the Oregon Fire Code, or
- 3) Conditions which, in the opinion of the Fire Code Official, constitute a distinct hazard to life or property.

TABLE OF CONTENTS

SECTION 1: FIRE DEPARTMENT APPARATUS ACCESS ROADS	4
1.1 Definitions	4
1.2 Fire Department Apparatus Access; General Regulations and Scope	4
1.3 Proximity of Buildings to Fire Apparatus Access Roads	5
1.4 Multiple Fire Apparatus Access Roads & Road Separation	5
1.5 Fire Apparatus Access Road Widths and Vertical Clearances	7
1.6 Aerial Fire Apparatus Access Road Widths	8
1.7 Fire Apparatus Access Road Surfaces and Load Capacities	9
1.8 Fire Apparatus Access Road Dead-Ends and Turnarounds	10
1.9 Bridges & Elevated Surfaces	11
1.10 Fire Apparatus Access Road Grades and Angles of Approach & Departure	12
1.11 Fire Apparatus Access Road Turning Radius	12
1.12 Gates on Fire Apparatus Access Roads	13
1.13 No Parking Signs & Painted Curbs	13
1.14 Fire Apparatus Access Roads during Construction Operations	14
SECTION 2: WATER SUPPLIES FOR SUPPRESSION OF FIRES	15
2.1 Definitions	15
2.2 Fire Flow Requirements for Buildings in Protected Areas WITHOUT Adequate and Reliable Water Systems	15
2.3 Fire Flow Requirements for Buildings in Protected Areas WITH Adequate and Reliable Water Systems	16
2.4 Water Supply during Construction or Demolition Operations	16
SECTION 3: FIRE HYDRANTS AND FIRE DEPARTMENT CONNECTIONS	17
3.1 Fire Hydrants and Fire Department Connections	17
3.2 Fire Hydrant Location and Distribution	17
SECTION 4: OTHER FIRE SERVICE FEATURES	18
4.1 Premises Identification	18
4.2 Key Boxes	18
4.3 Fire Department Access to Equipment	18
APPENDIX A-1: JURISDICTION CONTACT INFORMATION	19

SECTION 1: FIRE DEPARTMENT APPARATUS ACCESS ROADS

1.1 Definitions

These definitions are to assist with understanding terminology used regarding fire department apparatus access roads. Terms include both those from the Oregon Fire Code as well as terms that are used specifically within this document.

1. **Fire Apparatus Access Road.** See the definitions of “private driveway”, “fire lane”, and “private road”. Fire apparatus access roads provide access to a facility, building or portion thereof for use during emergency fire operations.
2. **Private Driveway** A private driveway serves not more than two dwellings or utility structures. Private driveways are not required to be open for access by the general public. Property owners bear the sole responsibility for all driveway construction, improvement, and maintenance.
3. **Fire Lane** A roadway or other passageway developed to allow movement of fire apparatus. A fire lane is not necessarily intended for routine vehicular traffic by the general public other than fire apparatus. Fire lanes are commonly used for the movement of fire apparatus on sites where buildings are located some distance from public streets and roads.
4. **Private Roads** A road that serves three or more dwellings or other structures. Private roads are not required to be open for routine access by the general public. Construction, improvement, and maintenance is the sole responsibility of the landowners who are served by the private road.
5. **Key Box** A secure, tamperproof device with a lock operable only by a fire department master key and containing building entry keys and other keys that may be required for access in an emergency.

1.2 Fire Department Apparatus Access; General Regulations and Scope

Required fire apparatus access roads shall be provided and maintained for every facility, building or portion of a building hereafter constructed or moved into or within the jurisdiction. **Oregon Fire Code Chapter 5**

For the purposes of this document, the terms “private driveway”, “fire lane”, and “private road” (defined in section 1.1), specify fire apparatus access roads that are within the scope of this document.

***NOTE:** Specifications and regulations for public streets and roads that are regulated by county or city governing bodies in accordance with ORS 368.039 are not within the scope of this document.*

Specifications:

1. Fire apparatus access roads and specifications are allowed to be modified where any of the following conditions apply:
 - a. A building has an automatic fire sprinkler system installed in accordance with the provisions of **Oregon Fire Code Chapter 9**.
 - b. Fire apparatus access roads cannot be installed because of location on property, topography, waterways, non-negotiable grades, or similar conditions. Under this condition, an approved alternate means of fire protection shall be provided as approved by the fire code official. Such approvals shall be granted on a case-by-case basis and shall not be precedent setting.

***NOTE:** Under this condition, a deed restriction will be recorded for the parcel in question to indicate that emergency vehicle access does not conform to the requirements of the Oregon Fire Code and as such, this condition makes the delivery of fire and life safety emergency services by the local fire department not possible within a timeframe that allows for efficient emergency scene mitigation.*

- c. Where there are no more than two dwellings (Group R-3) or utility (Group U) structures served by a fire apparatus access road.
2. Fire apparatus access roads shall be clearly delineated on submitted site plans and/or civil drawings. Plans shall contain sufficient information to allow the fire code official to conduct a thorough review.

1.3 Proximity of Buildings to Fire Apparatus Access Roads

Requirement:

The fire apparatus access road shall extend to within 150 feet of all portions of the facility and all portions of the exterior walls of the first story of the building as measured by an approved route around the exterior of the building or facility. **Oregon Fire Code Chapter 5**

An approved route generally follows the outline of a building and is not closer than 10 feet from the nearest edge of the building. This route follows where fire hoses may be deployed during fire operations.

Specifications:

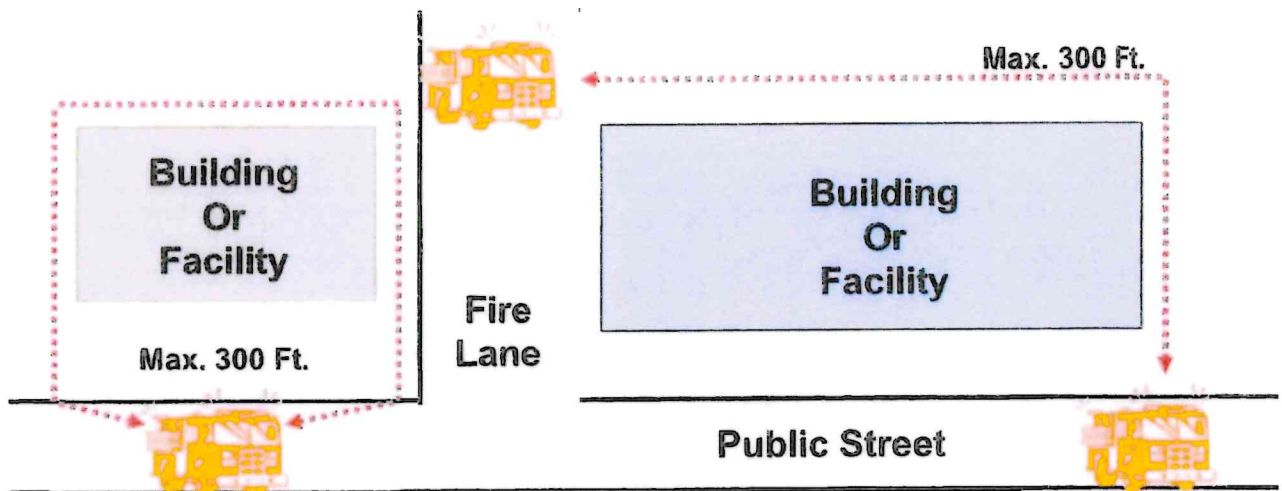

1.4 Multiple Fire Apparatus Access Roads & Road Separation

Requirement:

More than one fire apparatus access road may be required, based on the potential for impairment of a single road by vehicle congestion, condition of terrain, climatic conditions or other factors that could limit access. Access roads shall be located as required by the fire code official. **Oregon Fire Code Appendix D**

Specifications:

Refer to the Oregon Fire Code, Appendix D for specifications.

1. Two access roads are required under the following conditions:
 - a. One- and two-family dwellings (Group R-3) where there are more than 30 dwelling units with an exception for installation of automatic fire sprinkler systems.
 - The number of dwelling units accessed from a single fire apparatus access road shall not be increased unless fire apparatus access roads will connect with future development, as determined by the fire code official.

- b. Multiple-family residential developments (Group R-2) having more than 100 dwelling units with an exception for installation of automatic fire sprinkler systems installed within each structure.
 - c. Multiple-family residential developments (Group R-2) having more than 200 dwelling units regardless of whether they have an approved automatic fire sprinkler system installed within each structure.
 - d. At commercial or industrial developments with buildings or facilities having a gross building area of more than 62,000 square feet.
 - *Exception:* Projects having a gross building area of up to 124,000 square feet that have a single approved fire apparatus access road where *all* buildings are equipped throughout with approved fire sprinkler systems.
 - e. At commercial or industrial developments with buildings exceeding three stories or 30 feet in height.
2. Access roads shall be placed a distance apart equal to not less than one half of the length of the maximum overall diagonal dimension of the property or area to be served, measured in a straight line between accesses.
 3. The access roads shall enter onto a road that has access from two different directions.

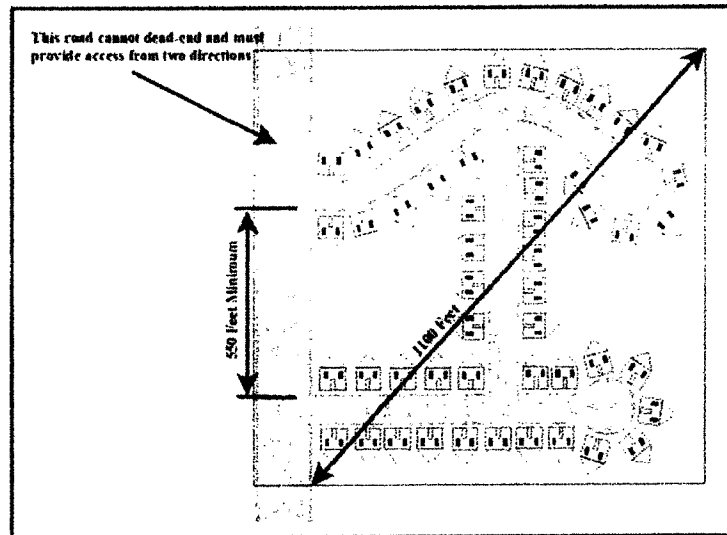

1.5 Fire Apparatus Access Road Widths and Vertical Clearances

Requirement:

All fire apparatus access roads must have a drivable surface for fire vehicle travel that is wide enough to allow their full, complete, and instant use during fire and other emergencies. **Oregon Fire Code Chapter 5**

Specifications:

1. Fire apparatus access roads shall have an unobstructed driving surface width of not less than 20 feet (26 feet adjacent to fire hydrants) and an unobstructed vertical clearance of not less than 13 feet 6 inches.

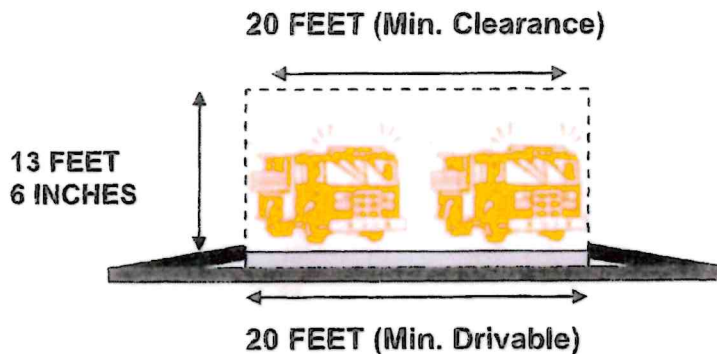

EXCEPTION: When serving two or less dwelling units or accessory buildings, the driving surface may be reduced to a width per the AHJ, although the unobstructed width shall be 20 feet. Turning radii for curves and turnarounds on reduced width roads shall be not less than 28 feet and 48 feet respectively, measured from the same center point.

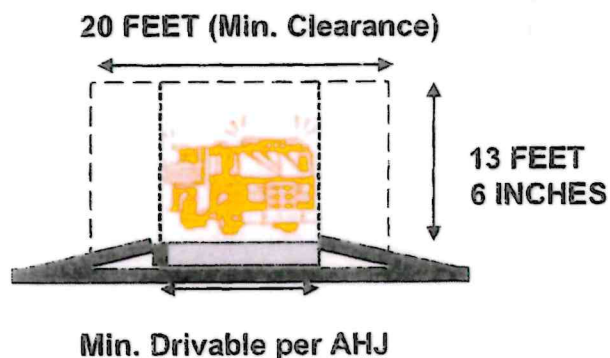

Requirement:

When a driveway exceeds 400 feet in length with a drivable surface less than 20 feet, turnouts shall be provided, unless otherwise approved by the fire code official. **Oregon Fire Code Chapter 5**

Specifications:

- a. Turnouts shall be 20 feet wide and 40 feet long at the widest part.
- b. Turnouts shall be located no more than 400 feet apart unless approved by the fire code official.
- c. The distances between turnouts, road intersections, and turnarounds may have the length modified based on visibility and line of sight distances.
- d. Visual indicators such as reflective markers shall be located to delineate the location and extent of turnouts.

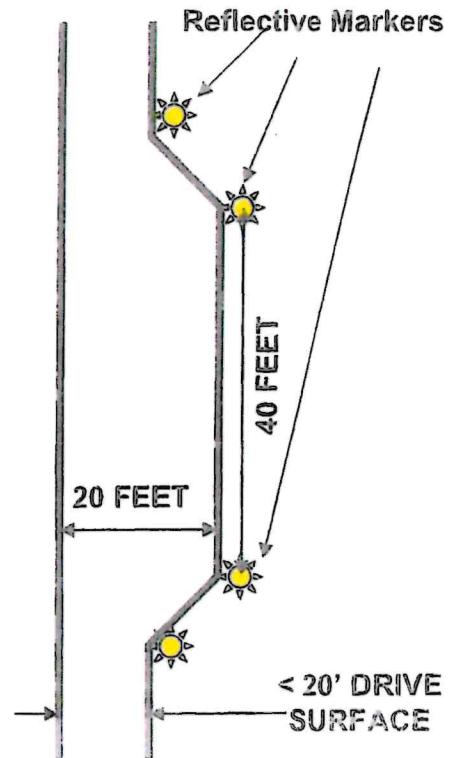
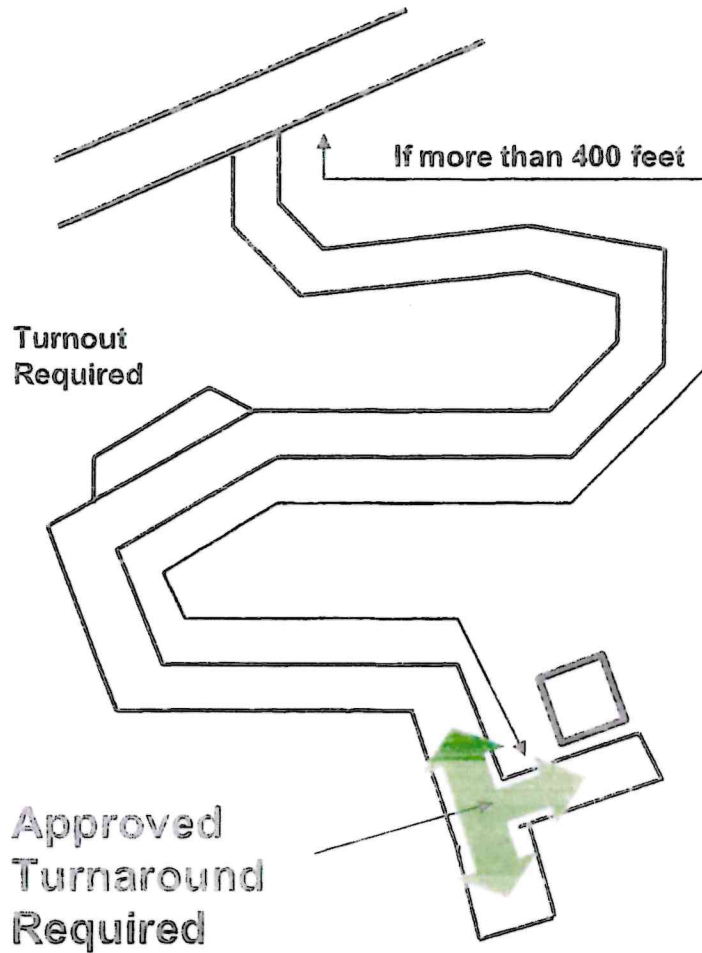

1.6 Aerial Fire Apparatus Access Road Widths

Requirement:

Buildings or portions of buildings or facilities exceeding 30 feet in height as measured above the lowest level of fire department vehicle access shall have fire apparatus access roads constructed for use by aerial apparatus. **Oregon Fire Code Chapter 5**

Specifications:

Refer to **Oregon Fire Code Appendix D** for specifications.

1. Fire apparatus access roads shall have an unobstructed driving surface width of not less than 26 feet and shall be in the immediate vicinity of any building or portion of building that is more than 30 feet in height.
2. At least one of the required fire apparatus access roads shall be located within a minimum of 15 feet and a maximum of 30 feet from the building and shall be positioned parallel to one entire side of the building.
3. Overhead utility and power lines shall not be located within the aerial fire apparatus access roadway.

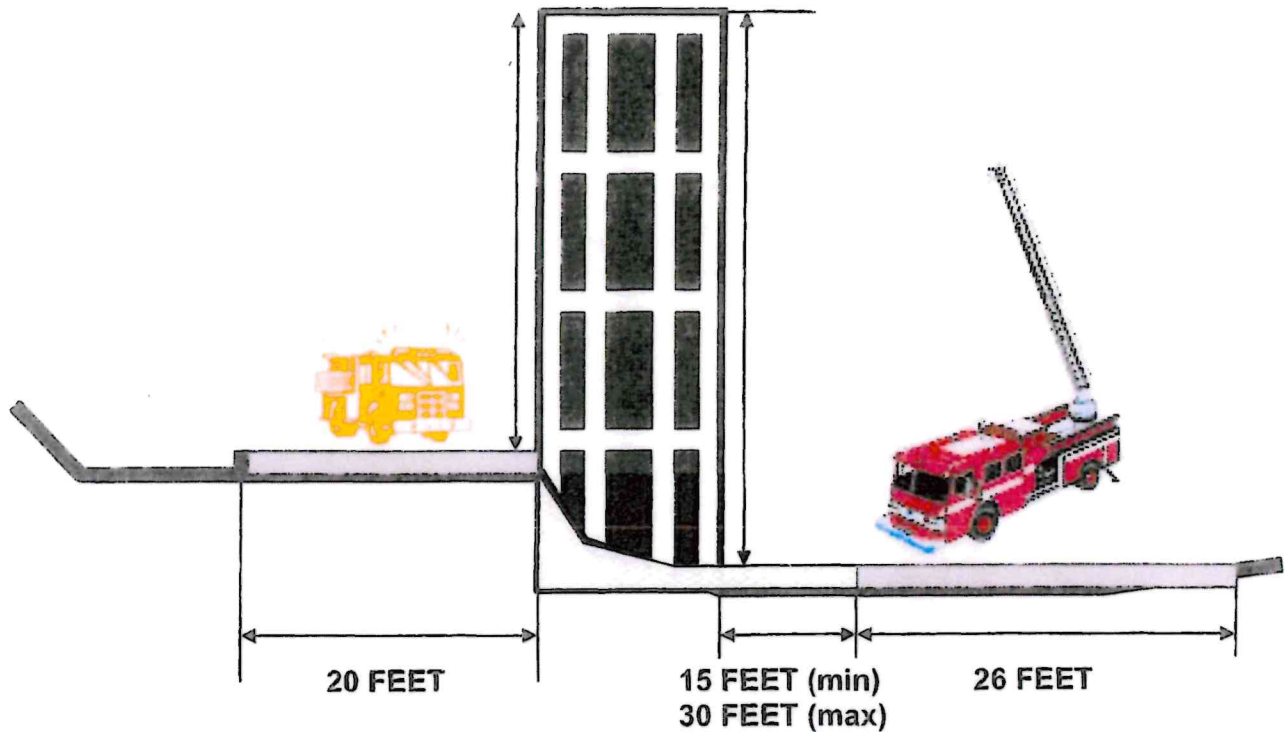

1.7 Fire Apparatus Access Road Surfaces and Load Capacities

Requirement:

Fire apparatus access roads shall be designed and maintained to support the imposed loads of fire apparatus and shall be surfaced so as to provide all-weather driving capabilities. **Oregon Fire Code Chapter 5**

Specifications:

Refer to **Oregon Fire Code Appendix D** for specifications.

1. Fire apparatus access roads shall be constructed of an all-weather surface (asphalt, concrete or other approved driving surface) that meets the following:
 - a. Easily distinguishable from the surrounding area by markings acceptable to the fire code official. Markings may include plantings, signs, or other arrangements acceptable to delineate the limits of fire access driving surfaces.
 - b. Capable of supporting not less than a 75,000-pound live load (gross vehicle weight).
 - c. The weight limit specified in section 1(b) above may be increased based upon the actual weight of fire apparatus vehicles serving the jurisdiction which provides structural fire protection services to the location.
2. Point loads may also need to be considered when designing fire apparatus access roads due to fire operations involving aerial fire apparatus which require the use of specialized jacking pads and outriggers.
3. The designed capacity of private roads and driveways must be documented in writing and shall be included with site plans and/or civil drawings.
4. Fire Apparatus Access Roads must be constructed and maintained as designed. An on-site inspection may be required by the fire code official and shall be performed by a registered design professional whenever conditions warrant.

1.8 Fire Apparatus Access Road Dead-Ends and Turnarounds

Requirement:

Dead-end fire apparatus access roads in excess of 150 feet in length shall be provided with an approved area for turning around fire apparatus. **Oregon Fire Code Chapter 5**

Specifications:

Refer to **Oregon Fire Code Appendix D** for specifications.

An approved turnaround is required if the remaining distance to an approved intersecting roadway, as measured along the fire apparatus access road, is greater than 150 feet.

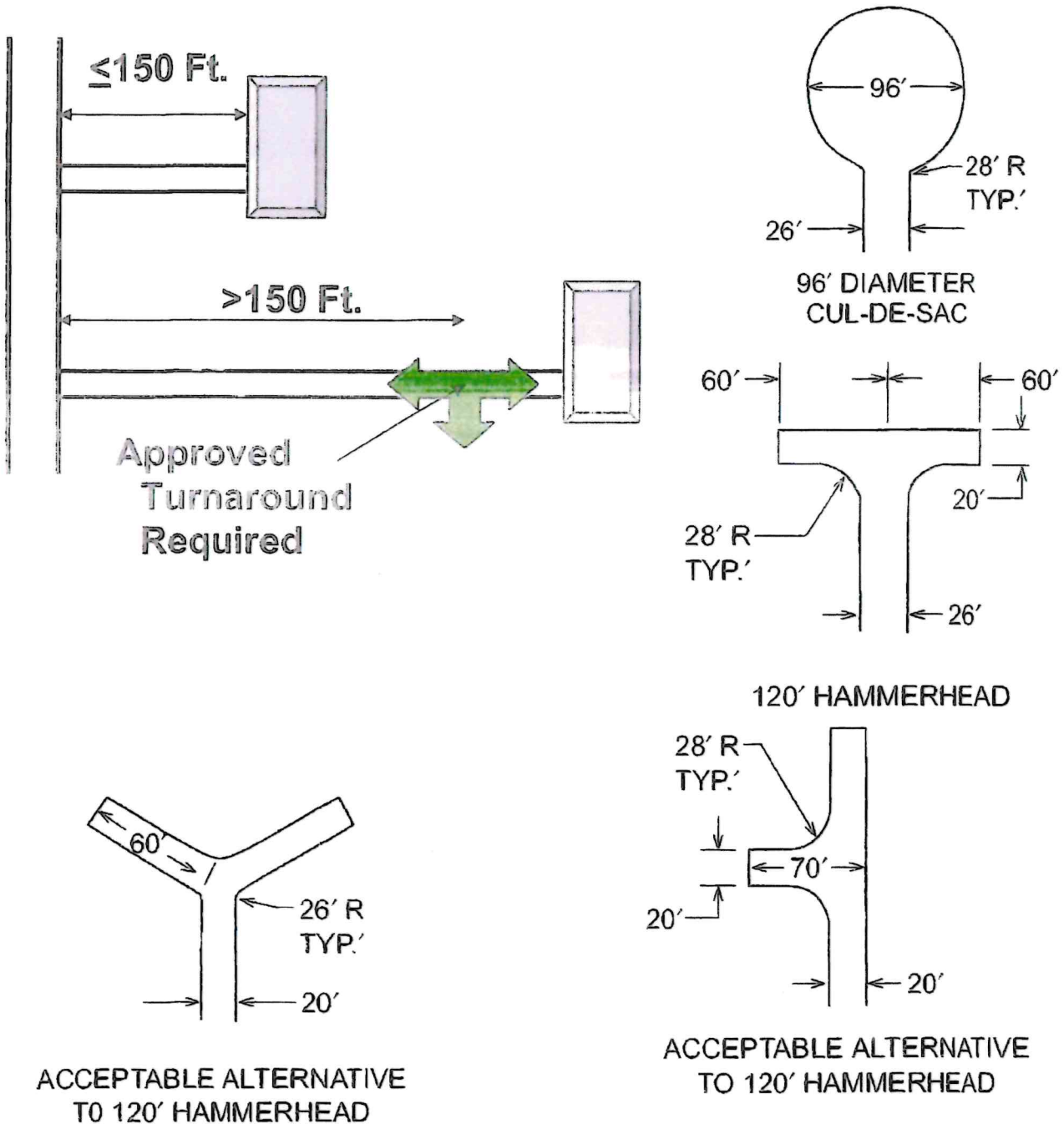

1.9 Bridges & Elevated Surfaces

Requirement:

Bridges that are part of fire apparatus access roads shall be constructed and maintained in accordance with AASHTO (American Association of State Highway and Transportation Officials) *Standard Specification for Highway Bridges*. **Oregon Fire Code Chapter 5**

Specifications:

1. Bridges shall be not less than 20 feet in drivable width.

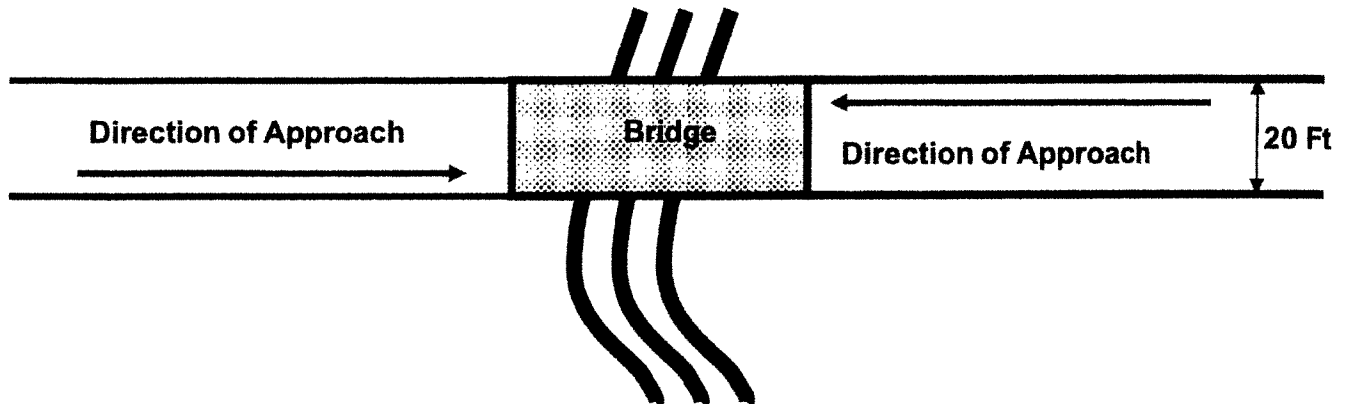

EXCEPTION: When serving two or less dwelling units or accessory buildings, the driving surface may be reduced to a width per the AHJ. Vehicle turnouts shall be constructed adjacent to bridges. Turnouts shall be located not less than 20 feet from each end of the bridge for cueing of fire vehicles that must cross.

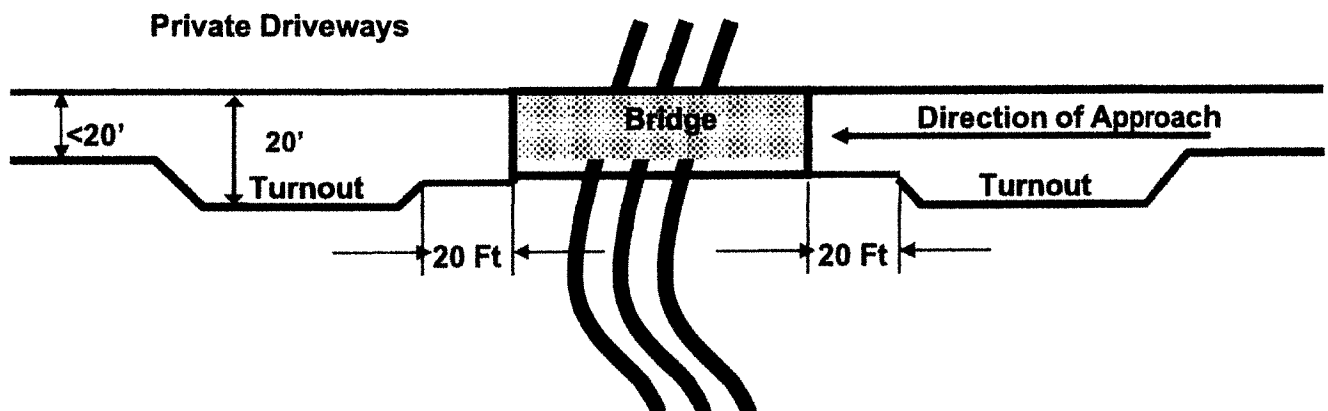

2. All bridges shall be designed for a live load sufficient to carry the imposed loads of fire apparatus in accordance with this document.
3. Newly constructed bridges shall be designed by a registered design professional.
4. Where elevated surfaces designed for emergency vehicle use are adjacent to surfaces which are not designed for such use, approved barriers, approved signs or both shall be installed and maintained to delineate the drivable surface. Where signs are required, they shall comply with the current *Manual on Uniform Traffic Control Devices* adopted by the State of Oregon.
5. Maintenance of existing bridges and elevated surfaces shall be the responsibility of the person or persons that have ownership of the bridge or elevated surface.

1.10 Fire Apparatus Access Road Grades and Angles of Approach & Departure

Requirement:

The maximum grade for all fire apparatus access road shall be within the limits established by the fire code official. **Oregon Fire Code Chapter 5**

Specifications:

1. Maximum grade on fire apparatus access roads shall not exceed 10 percent.

EXCEPTION: Where grades exceed 10 percent, the fire code official is authorized to accept, under the provisions of ORS 455.610(6):

- Up to 12 percent: Paved road surface.
 - Up to 15 percent: Paved road surface and an automatic fire sprinkler system installed in accordance with the provisions of **Oregon Fire Code Chapter 9**. Fire code officials may accept other alternative fire protection features.
 - Grades that exceed 15 percent: Paved road surface and an automatic fire sprinkler system installed in accordance with the provisions of **Oregon Fire Code Chapter 9**. A deed as called out in Section 1.2 of this document will apply.
2. Intersections, turnarounds, and water bars shall be essentially level with crowning allowed for water run-off (maximum of 5 percent grade allowed).
 3. Angles of approach and departure at the interface to and from fire apparatus access roads and where grades change shall be not more than 8 percent or as required by the design of responding fire apparatus, determined by the local fire authority. The angle shall be measured from the adjacent road surface.

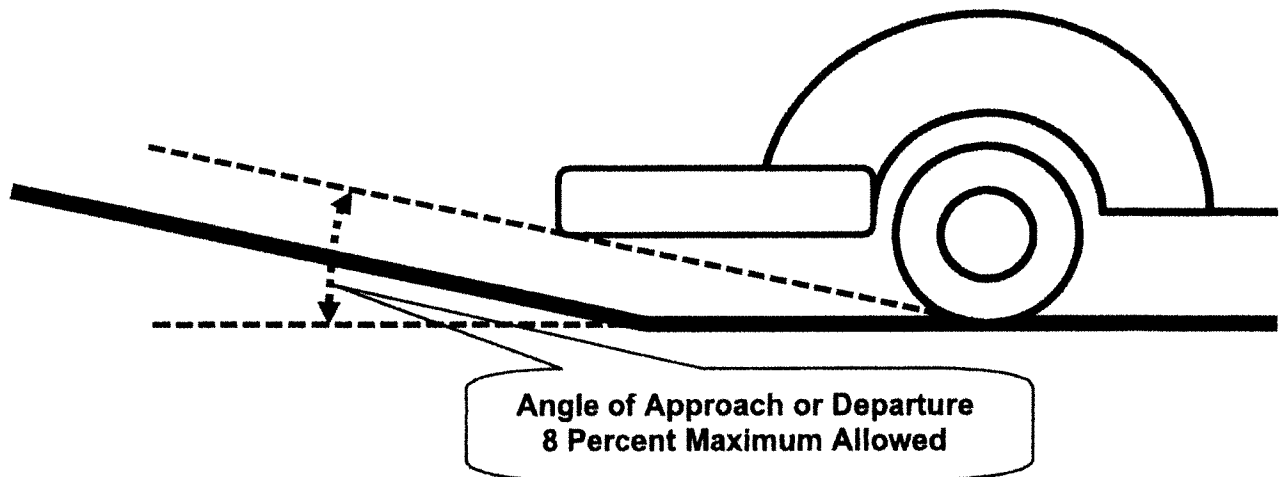

1.11 Fire Apparatus Access Road Turning Radius

Requirement:

All fire department apparatus access roads shall be constructed with respect for the anticipated fire apparatus vehicles that will provide emergency services to the specific location under consideration. The turning radius for access roads shall be as determined by the fire code official. **Oregon Fire Code Chapter 5**

Specifications:

Refer to **Oregon Fire Code Appendix D** for specifications.

1. The minimum inside turning radius shall not be less than 28 feet.
2. The minimum outside turning radius shall not be less than 48 feet (min. 96-foot diameter).

3. Both the inside and outside turning radius shall be measured from the same center point.

1.12 Gates on Fire Apparatus Access Roads

Requirement:

The fire code official is authorized to require the installation and maintenance of gates or other approved barricades across fire apparatus access roads. **Oregon Fire Code Chapter 5**

Specifications:

Refer to **Oregon Fire Code Appendix D** for specifications.

1. Gates shall be a minimum width of 20 feet wide (12 feet wide for divided roads).
2. Gates shall be of either the swinging or sliding type and may be either a single or double section.
3. Gates shall not reduce the minimum required width of the access road width when in a fully open position.
4. Gates that are power operated shall require the installation of a means to open the gate when there is a loss of power to the gate operating device. Gates shall be constructed to allow manual operation by a single person.
5. Gates and barricades shall be secured in an approved manner.
 - Gates secured with padlocks or chains and padlocks shall be capable of being opened by means of an approved lock or key box containing keys to the padlocks is installed at the gate location. As approved by the AHJ.
 - Where powered security gates are installed, they shall have an approved means of emergency operation as per the AHJ. The gates and their emergency operation shall be maintained operational at all times.
 - All security devices shall allow opening without undue delay of fire apparatus during emergencies.
6. Gates shall be set back from roadways not less than 30 feet and shall swing into the roadway that it serves.
7. Gates installed on private driveways, fire lanes, and other fire apparatus access roads shall not cause cross traffic to stop or create a hazardous traffic condition on the roadway when the access road is occupied by emergency apparatus or other large vehicles.
8. Gates components shall be maintained in an operative condition at all times and replaced or repaired when defective.

1.13 No Parking Signs & Painted Curbs

Requirement:

Approved signs shall be provided for fire apparatus access roads to identify such roads or to prohibit the obstruction thereof. Fire apparatus access roads shall be marked in an approved manner as specified by the fire code official and in accordance with this section. **Oregon Fire Chapter 5**

Specifications:

Signs shall comply with the current *Manual on Uniform Traffic Control Devices* adopted by the State of Oregon. Below are examples of acceptable signage. Signs shall meet the specifications for the R7 series and shall have red writing on a white reflective background.

Signs shall be a minimum size of not less than 12 inches by 18 inches.

Signs shall be constructed of 0.080 thickness aluminum.

Reflective sheeting shall be high intensity prismatic or better.

Signs or markings shall be maintained in a clean and legible condition at all times and shall be replaced or repaired when necessary to provide adequate visibility.

Examples of Fire Lane Signs



Other marking methods may be applied where approved by the fire code official.

Fire Lane or other fire operational area curbs, where required, shall be marked as follows:

- Curbs shall be painted per the specification of the AHJ or local ordinances.
- Curbs shall have the words, "Fire Lane, No Parking" stenciled and shall be legible and contrast with the background color.

1.14 Fire Apparatus Access Roads during Construction Operations

Requirement:

Fire apparatus access shall be provided by either temporary or permanent roads, capable of supporting vehicle loading under all weather conditions. **Oregon Fire Code Chapter 33**

Specifications:

1. Approved vehicle access for firefighting shall be provided to all construction or demolition sites. Vehicle access shall be provided to within 100 feet of temporary or permanent fire department connections.
2. Fire apparatus access roads shall be approved by the fire code official prior to beginning construction or demolition of buildings. Roads shall meet the requirements of this document.
3. Vehicle access shall be maintained until permanent fire apparatus access roads are available.

SECTION 2: WATER SUPPLIES FOR SUPPRESSION OF FIRES

2.1 Definitions

The definitions included in this section are to assist the reader with understanding terms that are used when fire flow requirements apply to buildings and facilities. Terms include those from the Oregon Fire Code as well as terms that are used in this document.

1. **Adequate And Reliable.** The fire flow rate as measured when water is flowing at not less than 1,500 gallons per minute and at not less than 20 pounds per square inch (psi) residual pressure.
2. **Fire Flow.** The flow rate of a water supply, measured at not less than 20 pounds per square inch (psi) residual pressure that is available for fighting fires.
3. **Protected Areas.** Geographic areas where a service or an agency has been established for the purposes of providing fire suppression services for buildings and other structures. Examples of agencies typically include public fire departments, rural fire protection districts, and private fire protection services.
4. **Fire Area** The living portion of a residence, plus attached garage/shop, covered porches/decks, usable attic, or basement space (capable of storage or future living area) shall constitute the total fire area in square feet.

2.2 Fire Flow Requirements for Buildings in Protected Areas WITHOUT Adequate and Reliable Water Systems

Requirement:

For residential dwellings with fire areas of 3,600 square feet or more, an approved water supply capable of supplying the required fire flow for fire protection shall be provided to premises upon which facilities, buildings or portions of buildings are hereafter constructed or moved into or within the jurisdiction. **Oregon Fire Code Chapter 5**

Specifications:

Refer to **Oregon Fire Code Appendix B** for specifications.

1. The provisions of **OFC Appendix section B107** are intended for use by the fire code official in protected areas in which adequate and reliable water supply systems do not exist or where water supply systems are incapable of meeting the provisions specified in this document.
2. When determining the fire flow for buildings in these areas, the fire code official is authorized to utilize any of the following nationally recognized methods:
 - NFPA 1142, *Standard on Water Supplies for Suburban and Rural Fire Fighting*, 2022 Edition.
 - The International Wildland Urban Interface Code; 2021 Edition.
 - ISO (Insurance Services Office) Document for Determining Needed Fire Flow, 2014 Edition.

Uniform Alternate Construction Standard (UACS) for One- and Two-Family Dwellings:

The Fire code Official has the authority to recognize alternative and equivalent methods and materials of design related to access and water supply as outlined in Chapter 1 or the Oregon Fire Code (Duties and Powers of the Fire Code Official). This references provisions of OAR 918-480-0125(4)(a-e): NFPA Standard 13D fire suppression systems, installation of additional layers of 5/8 inch Type-X gypsum, fire-resistive compartmentalization of dwelling fire areas, fire resistive exterior wall and roofing components, and/or fire separation containment in accordance with the default standards of the Wildland-Urban Interface rules (OAR 629-044-1060).

AM&M Specifications for separation of fire areas (no more than 3,599 sq. ft areas):

Fire separation achieved by two layers of 5/8 inch Type-X gypsum from foundation to roofline on one side of the separation, managing for all penetrations as appropriate (electrical/conduit/caulking, plumbing/caulking, HVAC/dampers, etc.). Doors utilized for access between spaces shall be 45-minute fire rated and self-closing. All AM&M specifications must be approved by the Building Official as recommended by the Fire Official.

2.3 Fire Flow Requirements for Buildings in Protected Areas WITH Adequate and Reliable Water Systems

Requirement:

An approved water supply capable of supplying the required fire flow for fire protection shall be provided to premises upon which facilities, buildings or portions of buildings are hereafter constructed or moved into or within the jurisdiction. **Oregon Fire Code Chapter 5**

Specifications:

Refer to **Oregon Fire Code Appendix B** for specifications.

1. The provisions of the **Oregon Fire Code Appendix B** shall apply to those areas where fire hydrants and water supply systems are present and that are capable of meeting the minimum specified fire flows specified as follows:
 - a. In areas with one- and two-family dwellings (Group R-3) only, the minimum fire flow shall be not less than 1,000 gallons per minute at not less than 20 pounds per square inch residual.
 - b. In areas with buildings and/or facilities (other than one- and two-family dwellings, Group R-3), the minimum fire flow shall be not less than 1,500 gallons per minute at not less than 20 pounds per square inch residual.
2. In all areas, fire flows may be reduced when automatic fire sprinkler systems and/or fire alarm systems are installed where otherwise not required by code or regulation. Reductions shall be in accordance with **Oregon Fire Code Appendix B**.
3. Based upon the type of occupancy (use) of buildings, the fire code official may modify fire flows in accordance with **Oregon Fire Code Appendix B**.
4. The fire code official may require limitations to fire flows for buildings and facilities where the development of fire flows in excess of 3,000 gallons per minute at not less than 20 pounds per square inch residual, are considered impractical. In such cases, the fire code official may be documented by **Oregon Fire Code Appendix B**.

2.4 Water Supply during Construction or Demolition Operations

Requirement:

An approved water supply for fire protection, either temporary or permanent, shall be made available as soon as combustible material arrives on construction sites. **Oregon Fire Code Chapter 33**

Specifications:

1. Fire protection water supplies shall be approved by the fire code official prior to the beginning of combustible construction of or demolition to buildings.
2. Fire protection water supplies shall meet the requirements of this document.

SECTION 3: FIRE HYDRANTS AND FIRE DEPARTMENT CONNECTIONS

3.1 Fire Hydrants and Fire Department Connections

Requirement:

Fire hydrants and fire department connections shall comply with the Oregon Fire Code as approved by the AHJ. **Oregon Fire Code Chapter 5**

3.2 Fire Hydrant Location and Distribution

Requirement:

Where a portion of the facility or building hereafter constructed or moved into or within the jurisdiction is more than 400 feet from a hydrant on a fire apparatus access road, as measure by an approved route around the exterior of the facility or building, on-site fire hydrants and mains shall be provided. **Oregon Fire Code Chapter 5**

Specifications:

Refer to **OFC Appendix C** for specifications.

1. Fire hydrants shall be provided along required fire apparatus access roads and adjacent public streets as required by the fire code official.
2. Where dwellings (Group R-3) or utility (Group U) structures only are located such as in residential subdivisions, the distance from a hydrant shall be not more than 600 feet.
3. Where buildings are equipped throughout with an approved automatic fire sprinkler system installed to either NFPA 13 or NFPA 13R, the distance from a fire hydrant shall be not more than 600 feet.
4. The number of fire hydrants available including consideration of existing fire hydrants, shall be in accordance with **Oregon Fire Code Appendix C**.
5. Distribution of fire hydrants shall be in accordance with **Oregon Fire Code Appendix C**.

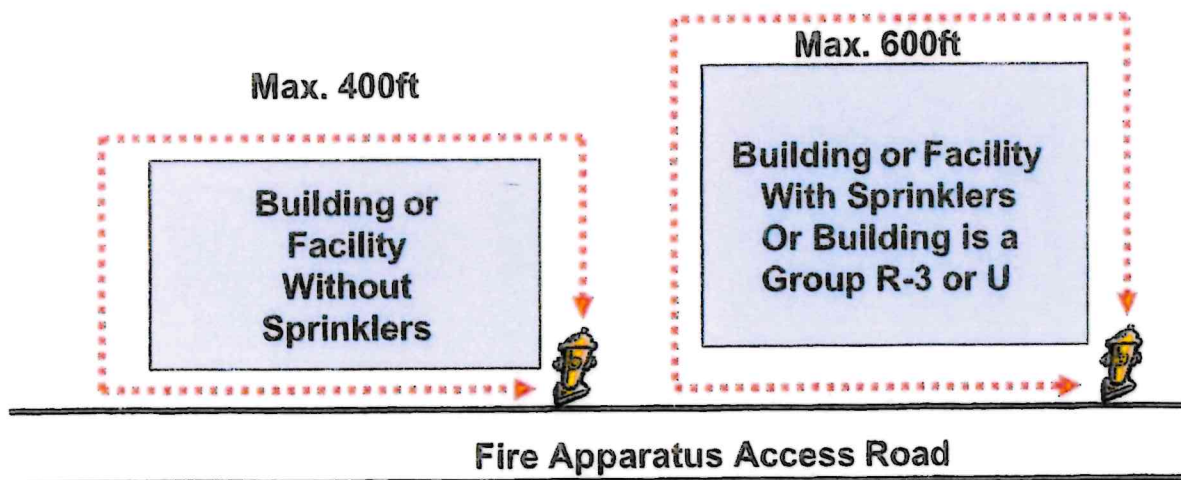

SECTION 4: OTHER FIRE SERVICE FEATURES

4.1 Premises Identification

Requirement:

New and existing buildings shall have approved address numbers, building numbers or other approved building identification. Streets and roads shall be identified with approved signs. **Oregon Fire Code Chapter 5**

4.2 Key Boxes

Requirement:

Where access to or within a structure or an area is restricted because of secured openings or where immediate access is necessary for lifesaving or fire-fighting purposes, the fire code official is authorized to require a key box to be installed. **Oregon Fire Code Chapter 5**

4.3 Fire Department Access to Equipment

Requirement:

Fire protection equipment shall be identified in an approved manner. **Oregon Fire Code Chapter 5**

APPENDIX A-1: JURISDICTION CONTACT INFORMATION

These are the addresses for the local and state fire code officials in Linn and Benton Counties. The development of this document is a joint effort among the listed jurisdictions.

Benton County Fire Districts & Fire Departments

	Adair RFPD	541-745-7212
	Alsea RFPD	541-487-8701
	Blodgett Summit RFPD	541-453-4406
	Corvallis FD	541-766-6961
	Hoskins-Kings Valley RFPD	541-929-2111
	Monroe RFPD	541-847-5170
	Philomath F&R	541-360-0032
	Albany FD	541-917-7700
Benton County:	Building Division	541-766-6819
	Planning Division	541-766-6819
City of Adair:	Building Department	541-766-6819
	Planning Department	541-766-6819
City of Alsea:	Building Department	541-766-6819
	Planning Department	541-766-6819
City of Blodgett-Summit:	Building Department	541-766-6819
	Planning Department	541-766-6819
City of Corvallis:	Development Services	541-766-6929
	Planning Division	541-766-6908
City of Hoskins-Kings Valley:	Building Department	541-766-6819
	Planning Department	541-766-6819
City of Monroe:	Building Department	541-766-6819
	Planning Department	541-766-6819
City of Philomath:	Building Department	541-929-6148
	Planning Department	541-929-6148

Oregon State Fire Marshal Office

Jason Cane, Regional Supervising Deputy 503-507-4495

Linn County Fire Districts & Fire Departments

Albany FD	541-917-7700
Brownsville RFD	541-466-5227
Halsey-Shedd RFPD	541-369-2419
Harrisburg F&R	541-995-6412
Idanha Detroit RFPD	503-854-3540
Jefferson RFPD	541-327-2822
Lebanon FD	541-451-1901
Lyons RFPD	503-859-2410
Mill City RFPD	503-897-2390
Scio RFPD	503-394-3000
Stayton RFPD	503-769-2601
Sweet Home Fire & Ambulance	541-367-5882
Tangent RFPD	541-928-8722

Linn County:	Building Codes Division	541-967-3816
City of Albany:	Building Department	541-917-7553
City of Brownsville:	Building Department	541-967-3816
City of Halsey - Shedd:	Building Department	541-967-3816
City of Harrisburg	Building Department	541-967-3816
City of Lebanon:	Building Department	541-258-4906
City of Lyons:	Building Department	541-967-3816
City of Scio	Building Department	541-967-3816
City of Sweet Home	Building Department	541-367-8113
City of Tangent	Building Department	541-223-3312



Fire Authority Plan Review Verification

Building Department Use Only

Permit Number _____

Date _____

Final Inspection(s): Access and Water Supply

Applicant Information

Permit Information

Name _____

Tax Lot Number _____

Mailing Address _____

Project Address: _____

City/State/ZIP _____

Phone Number _____

Email Address _____

Condition(s)

Condition(s) Completed (Date)

1.	
2.	
3.	
4.	

Notes

Fire Authority Approval

By: _____

Title: _____

Date: _____

Building finals will not be approved without sign off from the local fire authority stating all conditions have been met.

FIRE DEPARTMENT EMERGENCY RESPONSE VEHICLE ACCESS AND WATER SUPPLY WORKSHEET

THIS SECTION IS MEANT TO SERVE AS INFORMATION IN THE COMPLETION OF THE WORKSHEET

Residential, Commercial, and Agricultural structures SHALL provide reliable water and sufficient access to responding emergency vehicles. This code requirement falls under the Authority Having Jurisdiction (AHJ) being the Fire Department (FD) which has the heaviest and longest emergency response vehicles. Fire Safety & Life Safety is afforded to all within the State of Oregon, and FD Access & Water Supply is the minimal standard before any project begins. Access and Water Supply is required **during** the Land Development stage and addressed **before** designing the site and structure. The Fire Department has weight, length, height, width, and elevation requirements for their vehicles.

Water is the tool of choice for fighting fires. Firefighters require a reliable source of water for firefighting activities that protect them from fire, support life rescue operations, minimize property losses, and protects the community from fire spread. Reliable water sources are normally in the form of fire hydrants; however, some projects are outside of a municipal water grid. In support of allowing structures out of reach from the grid, the fire department allows for a source of water to be established on the property to supply the firefighters and equipment, for a minimum amount of time, based upon the location and size of the fire area. Well water can be used to supply the amount of water required even though their gallons per minute is insufficient to supply firefighting equipment directly.

This water supply is required for the entire life of the structure, or until a reliable water source or grid becomes available near-by.

All projects receive an access and water supply review, in which requirements may be made by the local Fire Authority. Alternate methods and materials (AM&M) may be submitted to the local Fire Authority for consideration. AM&M's for lots created on or after July 2, 2001 will require the Building Official's approval during building permit plans review. Make sure all AM&M's effecting the building plans are reflected accurately and included in the building design. Any changes to the project after the plans review has been completed must be resubmitted and reviewed for compliance and approval.

When filling out the worksheet, please be thorough with the requested information as the information will aid the local Fire Authority in the access and water supply review of the project. Each project is reviewed independently and is in no way precedent-setting on future projects. Please consult your local Fire Authority if you have any questions. Please include the following documents with this worksheet:

- A site plan that clearly identifies road width and segment lengths (as applicable), grades, turnout(s) as applicable, turnaround as applicable, and location of any bridge/culvert.
- A floor plan for the dwelling indicating total sq. ft. of living area, covered porch(es) or deck(s), attached garage/shop, attic/basement, etc. If using a separation wall, indicate proposed location(s) and specifications.

LINN-BENTON FIRE PROTECTION GUIDE:

<https://www.philomathfire.com/files/d7641c375/Linn+Benton+Fire+Protection+Guide+20230316.pdf>

FIRE AUTHORITY NOTES/CONDITIONS:



Building Department Use Only

Permit number: _____

Date: _____

**LINN-BENTON
FIRE AUTHORITY**

ACCESS AND WATER SUPPLY WORKSHEET

APPLICANT INFORMATION

NAME: _____

MAILING ADDRESS: _____

CITY/STATE/ZIP: _____

PHONE NUMBER: _____

EMAIL ADDRESS: _____

PERMIT INFORMATION

TAX LOT
NUMBER: _____

PROJECT ADDRESS:

Fire Area-The total area that can be affected by fire. Fire Area includes: living space, covered porches and decks, attached garage/shop, and basement and/or attic space if capable of storage or future living area.

NEW CONSTRUCTION N/A

LIVING AREA: _____ SQFT

COVERED PORCH OR DECK: _____ SQFT

GARAGE/SHOP (ATTACHED): _____ SQFT

OTHER SPACE (ATTIC/BASEMENT): _____ SQFT

TOTAL FIRE AREA: _____ SQFT

ADDITION/REMODEL N/A

EXISTING FIRE AREA: _____ SQFT

NEW LIVING AREA: _____ SQFT

NEW COVERED PORCH OR DECK: _____ SQFT

NEW GARAGE/SHOP (ATTACHED): _____ SQFT

NEW OTHER SPACE (ATTIC/BASEMENT): _____ SQFT

UPDATED FIRE AREA: _____ SQFT

ACCESS

NUMBER OF BUILDINGS ON ACCESS: _____

APPROACH IS 8 PERCENT OR LESS YES NO

WIDTH: _____ FT (MIN PER AHJ: _____ FT)

LENGTH: _____ FT HEIGHT: _____ FT

GRADE: _____ % (As measured at 25' increments)

TURN OUTS REQD (>400')? YES NO

75,000 # LOAD? ROCK? PAVED?

TURN AROUND WITHIN 50FT OF THE BUILDING

YES NO N/A

TURN AROUND DESIGN

Y T MOD T CULDESAC LOOP

IS THERE A BRIDGE OR CULVERT WITHIN THE ACCESS?

NO YES Oregon Engineer #: _____

WATER SUPPLY

Building Construction Type-The type of framing or support members

Building Construction Types:

1-Fire Resistive 2-Non-Combustible

3-Ordinary (Masonry) 4-Heavy Timber

5-Wood Framed (Typical Residential Home)

BUILDING CONSTRUCTION TYPE: _____

OTHER BUILDINGS CLOSER THAN 50FT? YES NO

IF YES: USE? _____ CU FT: _____

BUILDING HEIGHT TO THE PEAK: _____ FT

BUILDING HEIGHT TO THE EAVES: _____ FT.

CEILING HEIGHT: _____ FT. ATTIC HEIGHT: _____ FT.

ATTIC TYPE: STANDARD GAMBREL/MANSARD

RESIDENTIAL FIRE SPRINKLERS PROPOSED IN BUILDING

PLAN? YES NO

FIRE AUTHORITY USE ONLY

RECEIVED: _____ SITE VISIT? _____ 1142 CALCULATED GALLONS: _____

AM&M: YES NO CONDITIONAL: YES NO FIRE AUTHORITY SIGNATURE: _____